

阅读申明

- 1.本站收集的数据手册和产品资料都来自互联网，版权归原作者所有。如读者和版权方有任何异议请及时告之，我们将妥善解决。
- 2.本站提供的中文数据手册是英文数据手册的中文翻译，其目的是协助用户阅读，该译文无法自动跟随原稿更新，同时也可能存在翻译上的不当。建议读者以英文原稿为参考以便获得更精准的信息。
- 3.本站提供的产品资料，来自厂商的技术支持或者使用者的心得体会等，其内容可能存在描述上的差异，建议读者做出适当判断。
- 4.如需与我们联系，请发邮件到marketing@iczoom.com，主题请标有“数据手册”字样。

Read Statement

1. The datasheets and other product information on the site are all from network reference or other public materials, and the copyright belongs to the original author and original published source. If readers and copyright owners have any objections, please contact us and we will deal with it in a timely manner.
2. The Chinese datasheets provided on the website is a Chinese translation of the English datasheets. Its purpose is for reader's learning exchange only and do not involve commercial purposes. The translation cannot be automatically updated with the original manuscript, and there may also be improper translations. Readers are advised to use the English manuscript as a reference for more accurate information.
3. All product information provided on the website refer to solutions from manufacturers' technical support or users the contents may have differences in description, and readers are advised to take the original article as the standard.
4. If you have any questions, please contact us at marketing@iczoom.com and mark the subject with "Datasheets" .

Compact Sensor Offers Long Sensing Distance and Superior Noise-Immunity

- Photo-IC provides long sensing distance: 15 m for through-beam, 4 m for retroreflective, and 1 m for diffuse
- Integrated Photo-IC improves noise immunity to interference from inverters and other inductive loads
- New injection molding technology assures IP67 rating to withstand water and dust
- Switch-selectable, Light-ON/Dark-ON operation
- M8 connector-ready and 2-m, pre-wired models
- NPN or PNP output models available



Ordering Information

■ SENSORS

Sensing method	Light source	Appearance	Connection method	Sensing distance	Part number	
					NPN output	PNP output
Through-beam	IR		Pre-wired	15 m	E3Z-T61	E3Z-T81
			Connector		E3Z-T66	E3Z-T86
Polarized retroreflective	RED		Pre-wired	100 mm to 4 m 100 mm to 3 m (See Note 2.)	E3Z-R61	E3Z-R81
			Connector		E3Z-R66	E3Z-R86
Diffuse reflective	IR		Pre-wired	5 to 100 mm (wide view)	E3Z-D61	E3Z-D81
			Connector		E3Z-D66	E3Z-D86
			Pre-wired	1 m	E3Z-D62	E3Z-D82
			Connector		E3Z-D67	E3Z-D87

Note: 1. The Reflector is sold separately. Select the Reflector model most suited to the application.

2. Sensing distance can be extended to 4 meters when the E39-R1S reflector is used. The sensing distance is 3 meters when the E39-R1 reflector is used.

■ ACCESSORIES (ORDER SEPARATELY)

Slit for Through-beam Models (E3Z-T□□)

Order a slit for each emitter and receiver.

Slit width	Sensing distance (typical)	Minimum sensing object (typical)	Part number
0.5 mm dia.	50 mm	0.5 mm dia.	E39-S65A
1 mm dia.	200 mm	1 mm dia.	E39-S65B
2 mm dia.	800 mm	2 mm dia.	E39-S65C
0.5 × 10 mm	1 m	0.7 mm dia.	E39-S65D
1 × 10 mm	2.2 m	1.2 mm dia.	E39-S65E
2 × 10 mm	5 m	2.4 mm dia.	E39-S65F

Reflectors for Retroreflective Models

Name	Sensing distance (typical)	Part number
Reflector	100 mm to 3 m	E39-R1
	100 mm to 4 m	E39-R1S
	100 mm to 5 m	E39-R2
	100 mm to 2.5 m	E39-R9
	100 mm to 3.5 m	E39-R10
Miniature Reflector	50 mm to 1.5 m	E39-R3
Tape Reflector	150 mm to 700 mm	E39-RS1
	150 mm to 1.1 m	E39-RS2
	150 mm to 1.4 m	E39-RS3

Note: The actual sensing distance may be reduced to approximately 70% of the typical sensing distance when using a Reflector other than the E39-R1 or the E39-R1S.

■ MOUNTING BRACKETS

Appearance	Description	Part number
	L-bracket, horizontal	E39-L104
	L-bracket, vertical	E39-L44
	Open top, 20° angle adjustability	E39-L43
	Protected top 5° angle adjustability	E39-L144

Appearance	Description	Part number
	Compact vertical protective cover bracket	E39-L142
	Vertical protective cover bracket	E39-L98

Note: If a through-beam model is used, order two Mounting Brackets — one for the emitter and one for the receiver.

M8 Connectors

Appearance	Cable type		Part number
Straight	2 m (6.56 ft)	Four-wire type	XS3F-M421-402-A
	5 m (16.40 ft)		XS3F-M421-405-A
Right angle	2 m (6.56 ft)		XS3F-M422-402-A
	5 m (16.40 ft)		XS3F-M422-405-A

Specifications

Item	Sensing method		Through-beam	Polarized retroreflective	Diffuse reflective	
	NPN output		E3Z-T61/T66	E3Z-R61/R66	E3Z-D61/D66	E3Z-D62/D67
	PNP output		E3Z-T81/T86	E3Z-R81/R86	E3Z-D81/D86	E3Z-D82/D87
Sensing distance	15 m		100 mm (4 m Note 1) (when using E39-R1S) 100 mm (3 m Note 2) (when using E39-R1)	White paper (100 × 100 mm): 100 mm	White paper (300 × 300 mm): 1 m	
Standard sensing object	Opaque: 12 mm (dia. min.)		Opaque: 75 mm (dia. min.)	---		
Hysteresis	---			20% max. of setting distance		
Directional angle	Both emitter and receiver: 3 to 15°		2 to 10°		---	
Light source (wave length)	Infrared LED (860 nm)		Red LED (680 nm)		Infrared LED (860 nm)	
Power supply voltage	12 to 24 VDC ±10% including 10% (p-p) max. ripple					
Current consumption	Emitter: 15 mA Receiver: 20 mA		30 mA max.			
Control output	100 mA max. at 26.4 VDC, open collector output (residual voltage: 1 V max.) L-ON/D-ON, switch selectable					
Circuit protection	Load short-circuit and reversed power supply protection		Reversed power supply connection, output short-circuit, and mutual interference protection			
Response time	1 ms max.					
Sensitivity adjustment	One-turn potentiometer					
Ambient illumination (receiver side)	Incandescent lamp		3,000 lux max.			
	Sunlight		10,000 lux max.			
Ambient temperature	Operating		-25°C to 55°C (-13°F to 131°F)			
	Storage		-40°C to 70°C (-40°F to 158°F) with no icing or condensation			
Ambient humidity	Operating		35% to 85%			
	Storage		35% to 95% with no condensation			
Insulation resistance	20 MΩ min. at 500 VDC					
Dielectric strength	1,000 VAC, 50/60 Hz for 1 min					
Vibration resistance	10 to 55 Hz, 1.5-mm double amplitude or 300 m/s ² for 2 hours each in X, Y, and Z axes					
Shock resistance	Destruction		500 m/s ² 3 times each in X, Y, and Z axes			
Enclosure rating	IP67 (IEC60529)					
Approvals	CE					
Connection method	2 m cable or M8 connector					
Indicator	Operation indicator (orange) Stability indicator (green) Emitter has power indicator (orange) only					
Weight (packed state)	Pre-wired cable (2 m)		Approx. 120 g (4.2 oz)		Approx. 65 g (2.3 oz)	
	Connector		Approx. 30 g (1.1 oz)		Approx. 20 g (0.7 oz)	
Material	Case: PBT (polybutylene terephthalate); Lens: Methacrylate resin					
Accessories	Instruction manual (Order Reflector and Mounting Bracket separately.)					

- Note:** 1. Sensing distance can be extended up to 4 meters when the E39-R1S reflector is used.
2. Sensing distance can be extended up to 3 meters when the E39-R1 reflector is used.

Nomenclature

Through-beam Models
E3Z-T6□ Receiver

Retroreflective Models
E3Z-R6□

Diffuse-reflective Models
E3Z-D6□



Operation

OUTPUT CIRCUITS

Model	E3Z-T61/-T66/-R61/-R66/-D61/-D66/-D62/-D67	
NPN output	Through-beam receiver Retroreflective model Diffuse reflective model	Through-beam emitter
Model	E3Z-T81/-T86/-R86/-D81/-D86/-D82/-D87	
PNP output	Through-beam receiver Retroreflective model Diffuse reflective model	Through-beam emitter
Connector pin arrangement	<p>Pin 2 is open.</p>	<p>Pins 2, 4 are open.</p>

TIMING CHARTS

Light-ON (L-ON) Operation

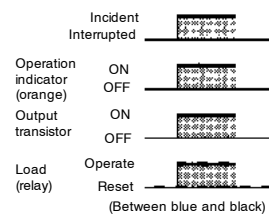

Dark-ON (D-ON) Operation

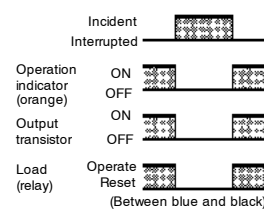

CONNECTOR PIN-OUT

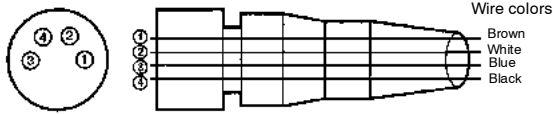

XS3F-M421-402-A XS3F-M421-405-A
 XS3F-M422-402-A XS3F-M422-405-A

Classification	Wire color	Connector pin No.	Use
DC	Brown	A	Power supply (+V)
	White	B	Pin 2 is not used.
	Blue	C	Power supply (0 V)
	Black	D	Output

Note: The through-beam emitter does not use pins 2 and 4.

Engineering Data

PARALLEL OPERATING RANGE (TYPICAL)

Through-beam Models
 E3Z-T□1 (T□6)

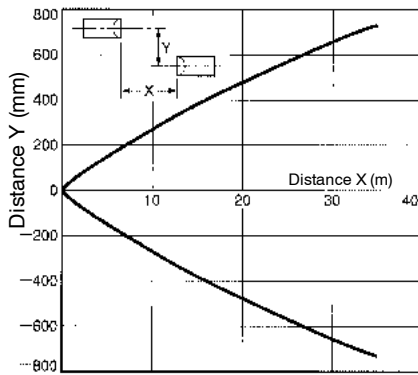

Through-beam Models
 E3Z-T□1 (T□6) and Slit

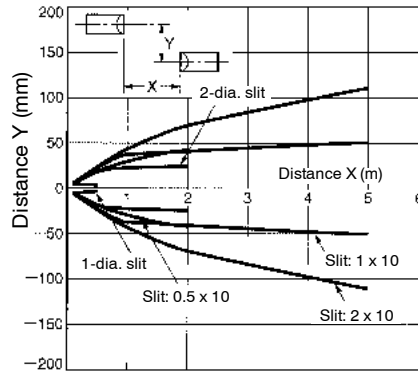

Retroreflective Models
 E3Z-R□1 (R□6) and Reflector

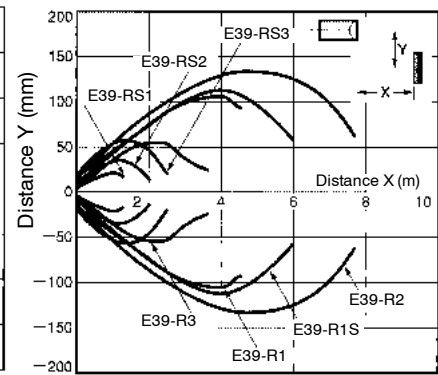

OPERATING RANGE (TYPICAL)

Diffuse Reflective Models
 E3Z-D□1 (D□6)

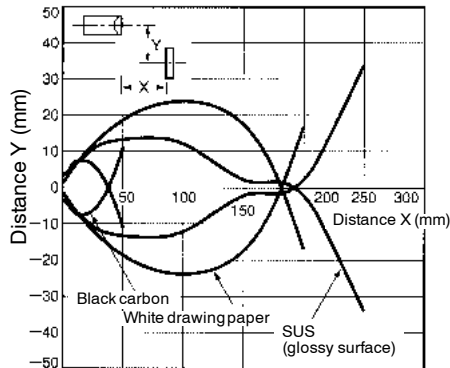

Diffuse Reflective Models
 E3Z-D□2 (D□7)

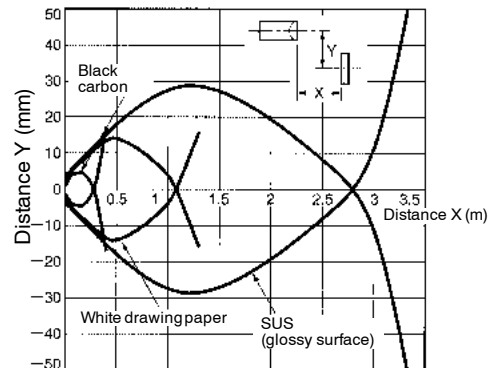

■ EXCESS GAIN RATIO VS. DISTANCE (TYPICAL)

Through-beam Models
E3Z-T□1 (T□6)

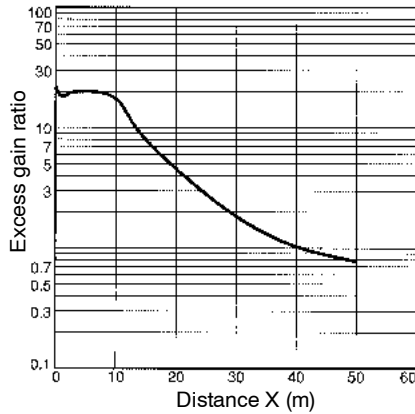

Retroreflective Models
E3Z-R□1 (R□6) and Reflector



Diffuse Reflective Models
E3Z-D□1 (D□6)

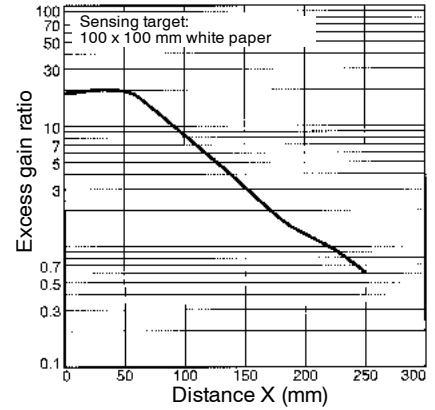

Diffuse Reflective Model
E3Z-D□2 (D□7)

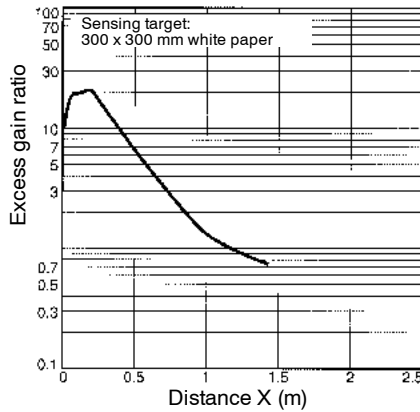

Sensing Target Size vs. Sensing Distance (Typical)

Diffuse Reflective Models
E3Z-D□1 (D□6)

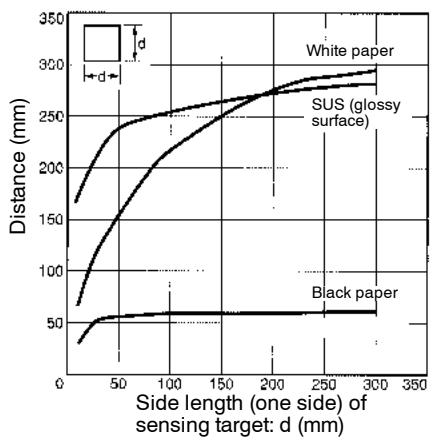

Diffuse Reflective Models
E3Z-D□2 (D□7)



Dimensions

Unit: mm (inch)

SENSORS

Through-beam (Pre-wired Models)

E3Z-T61
E3Z-T81

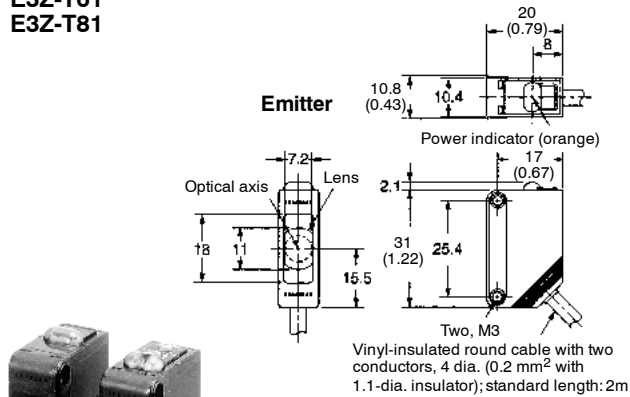

Through-beam (Connector Models)

E3Z-T66
E3Z-T86

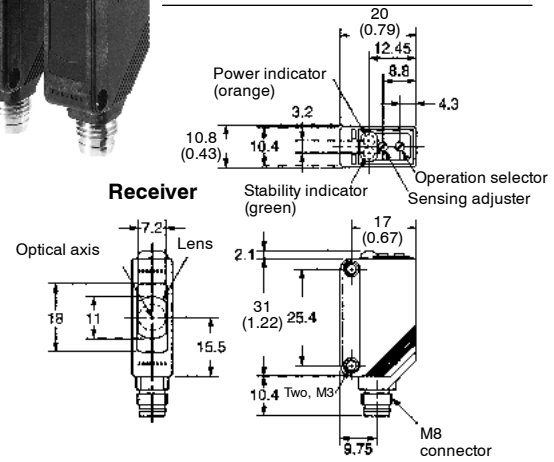
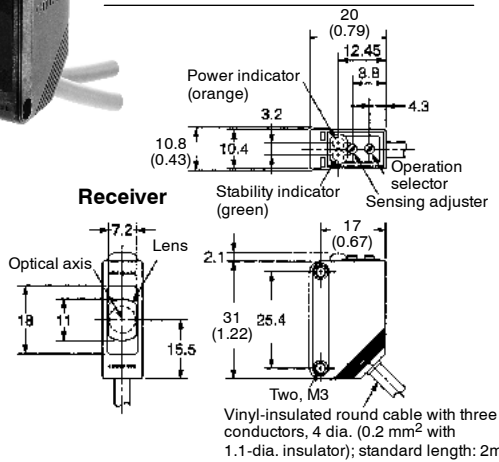
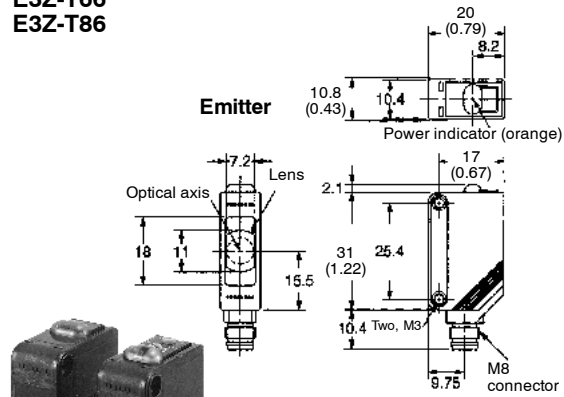

Retroreflective Models (Pre-wired Models)

E3Z-R61
E3Z-R81

Diffuse Reflective Models (Pre-wired Models)

E3Z-D61
E3Z-D62
E3Z-D81
E3Z-D82

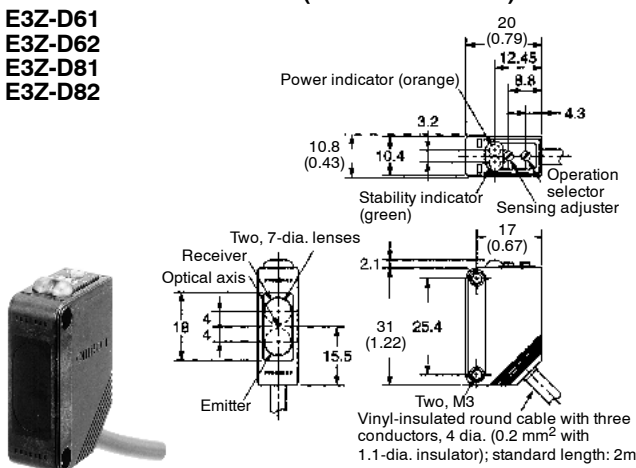

Retroreflective Models (Connector Models)

E3Z-R66
E3Z-R86

Diffuse Reflective Models (Connector Models)

E3Z-D66
E3Z-D67
E3Z-D86
E3Z-D87

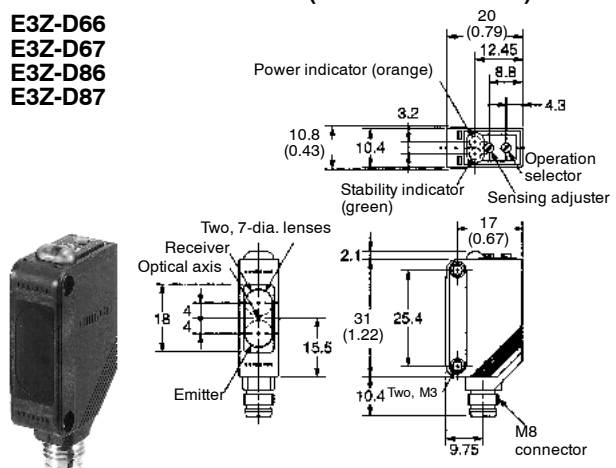

Unit: mm (inch)

■ SLITS

E39-S65A
E39-S65B
E39-S65C

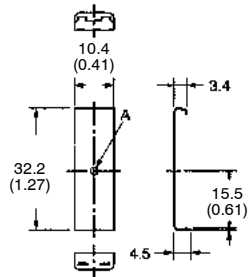

Model	Side A	Material
E39-S65A	0.5 dia.	SUS301 stainless steel
E39-S65B	1.0 dia.	
E39-S65C	2.0 dia.	

E39-S65D
E39-S65E
E39-S65F

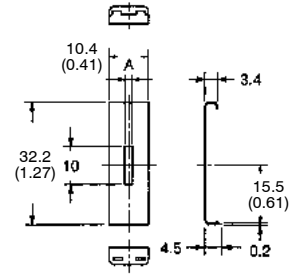

Model	Side A	Material
E39-S65D	0.5	SUS301 stainless steel
E39-S65E	1.0	
E39-S65F	2.0	

■ REFLECTORS

E39-R1
E39-R1S



Material
Surface: Acrylic resin
Backside: ABS resin



E39-R2

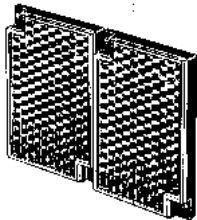

Material
Surface: Acrylic resin
Backside: ABS resin



E39-R9



Material
Reflecting surface: Acrylic resin
Back: ABS resin

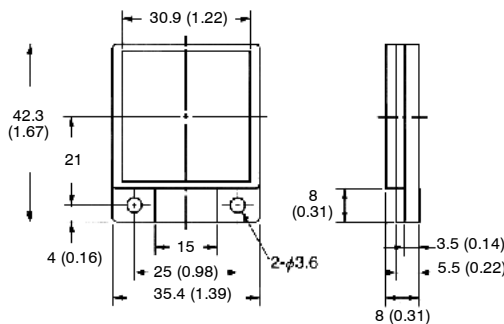

E39-R10

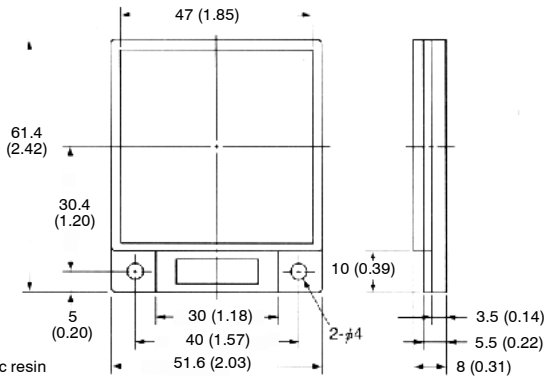

Material
Reflecting surface: Acrylic resin
Back: ABS resin

MINIATURE REFLECTOR

E39-R3

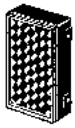

Material
Surface: Acrylic resin
Backside: ABS resin

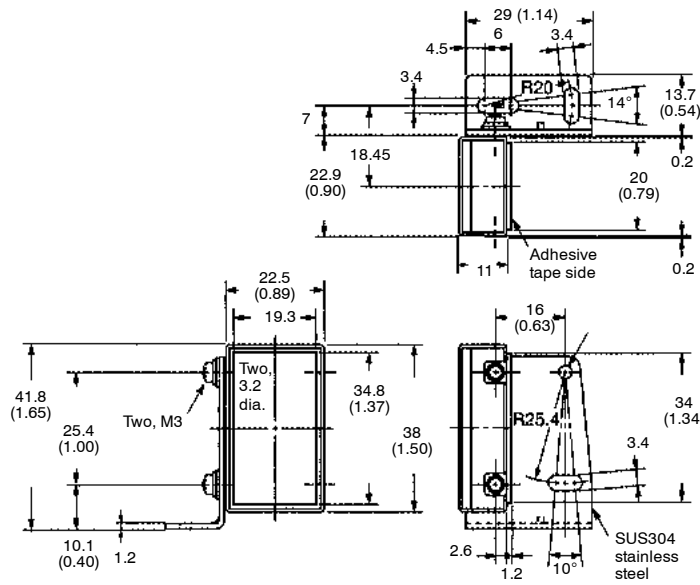

TAPE REFLECTORS

E39-RS1



Material:
Acrylic resin

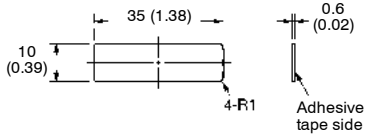

E39-RS2

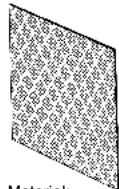

Material:
Acrylic resin

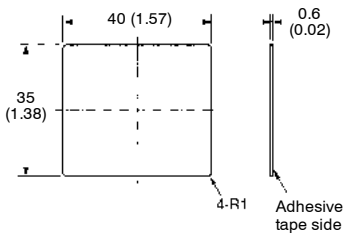

E39-RS3

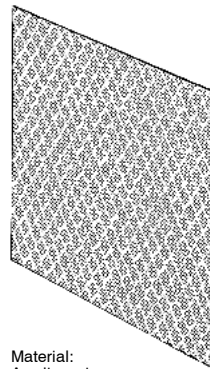

Material:
Acrylic resin

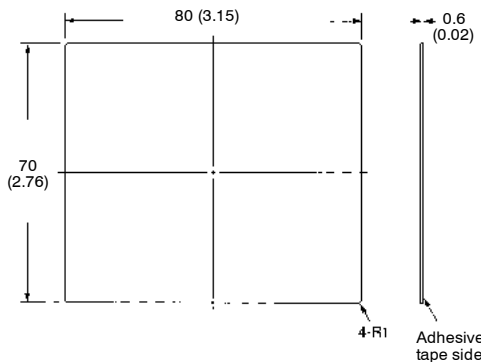

Unit: mm (inch)

■ MOUNTING BRACKETS

E39-L104



Material:
SUS304
stainless steel

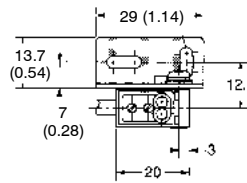
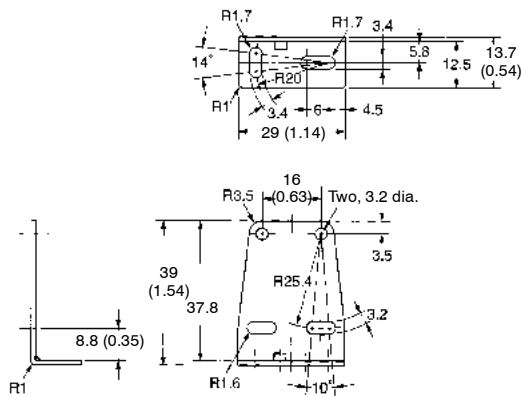

With Mounting Bracket
(E3Z-D62)



E39-L43

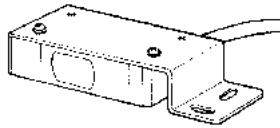

Material:
SUS304
stainless steel

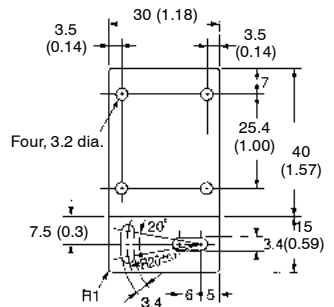
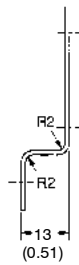

With Mounting Bracket
(E3Z-D62)

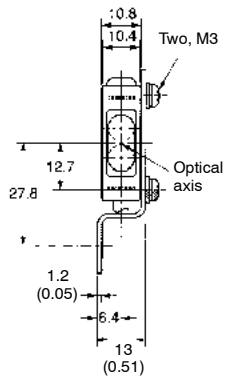

E39-L44

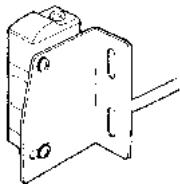

Material:
SUS304
stainless steel

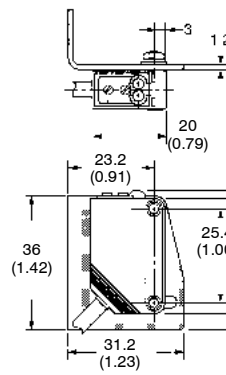
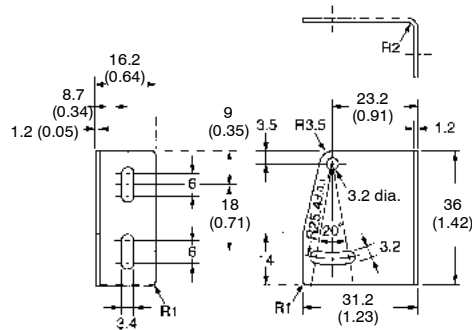

With Mounting Bracket
(E3Z-D62)

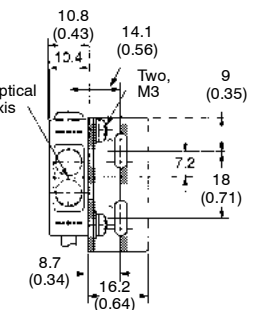

E39-L144

Material:
SUS304 stainless steel

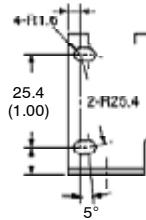
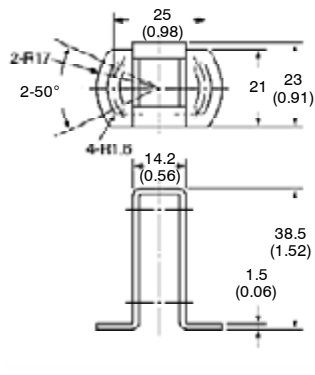

With Sensor
(Example: E3Z-L61)

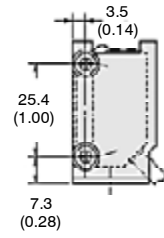
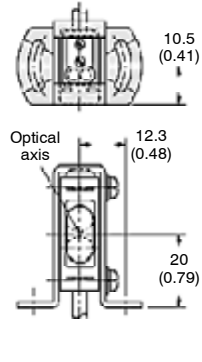

E39-L142

Material:
SUS304 stainless steel

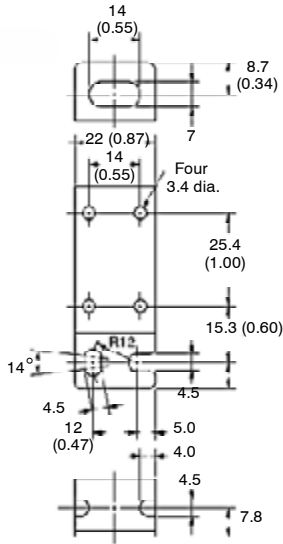
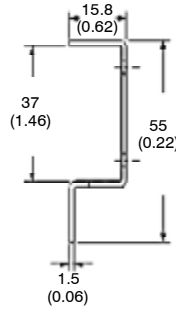

With Sensor
(Example: E3Z-L61)

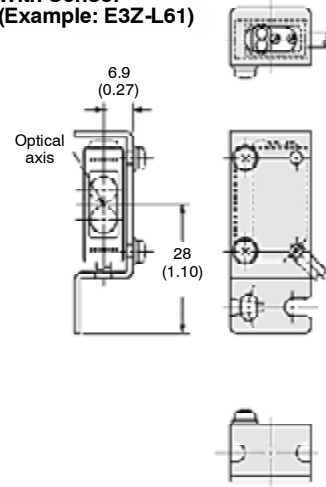

Unit: mm (inch)

E39-L93

E39-L98

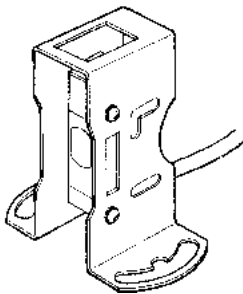

Material:
SUS304 stainless steel

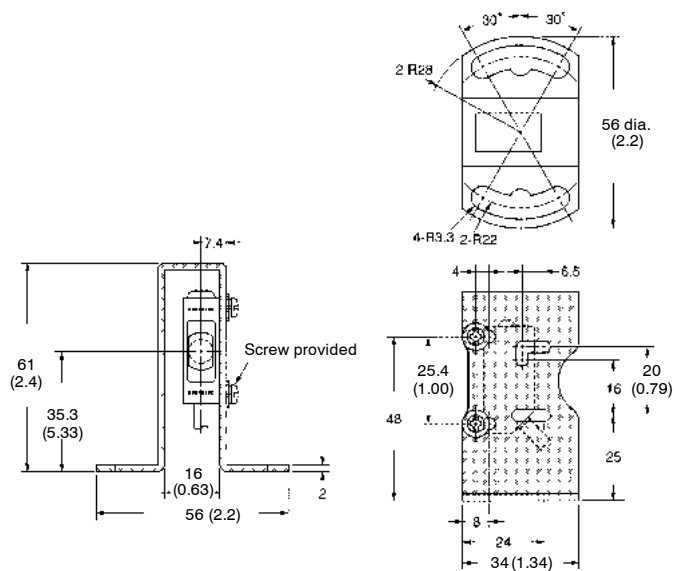

Mounting Holes

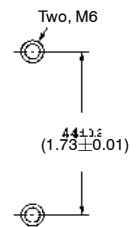

■ M8 CONNECTOR CORDSETS

Straight

XS3F-M421-402-A (L=2 m)
XS3F-M421-405-A (L=5 m)

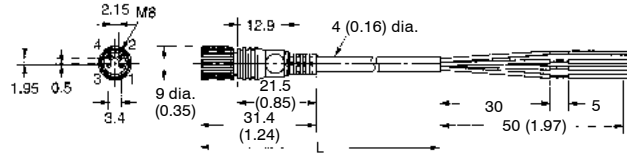

Right Angle

XS3F-M422-402-A (L=2 m)
XS3F-M422-405-A (L=5 m)



Precautions

To ensure safe sensor operation, please follow the following precautions:

■ WIRING

Power Supply Voltage

Make sure that the power supply to the Sensor is within the rated voltage range.

Load Short-circuiting

Do not short-circuit the load, or the Sensor may be damaged.

Polarity

Correct polarity wiring is required to prevent damage to the sensor.

Connection Without Load

Do not connect power supply to the Sensor with no load connected, or the internal elements may explode or burn.

■ OPERATING ENVIRONMENT

Do not use the Sensor in locations with explosive or flammable gas.

■ SETTINGS

Power Reset Time

The Sensor is ready to operate 100 ms after the Sensor is turned ON. If the load and Sensor are connected to independent power supplies respectively, be sure to turn ON the Sensor before turning the load ON.

■ CONNECTIONS

M8 Metal Connector

- Turn off power before disconnecting the sensor.
- Remove the connector cover before connecting or disconnecting the metal connector.
- Secure the connector cover by hand. Do not use any pliers, or the connector may be damaged.
- The proper tightening torque range is between 0.3 and 0.4 N • m. Be sure to tighten the connector securely in order to maintain the the specified degree of protection and to keep the connector from loosening due to vibration.

■ MOUNTING

Use M3 screws to mount the sensor and tighten each screw to a maximum torque of 0.53 N • m.



■ ADJUSTMENT

Slits for Through-beam Models (E39-S65A/B/C/D/E/F) Sold Separately

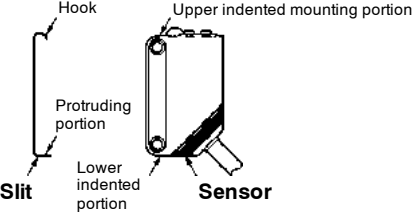
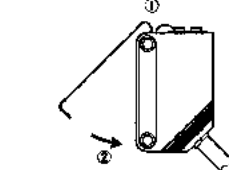
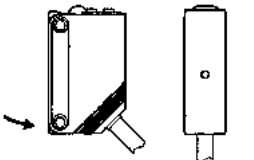
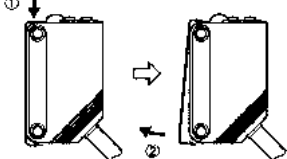
 <p>Hook Upper indented mounting portion Protruding portion Lower indented portion Slit Sensor</p>	
<p>Mounting Method</p> <ol style="list-style-type: none"> 1. Hook the upper protruding portion of the Slit to the upper indented mounting portion of the Sensor and adjust the position of the Slit so that the Slit will be in parallel to the lens side of the Sensor. 2. Press the lower protruding portion of the Slit onto the indented mounting portion of the Sensor until the Slit snaps in. 	
<p>Mounting Condition</p>	<p>Side View Front View</p> 
<p>Removal Method</p> <ol style="list-style-type: none"> 1. Press the upper portion of the Slit. 2. Disconnect the lower protruding portion of the Slit from the Sensor and remove the Slit. 	

NOTE: DIMENSIONS SHOWN ARE IN MILLIMETERS. To convert millimeters to inches divide by 25.4.

OMRON[®]
OMRON ELECTRONICS LLC
 One East Commerce Drive
 Schaumburg, IL 60173
1-800-55-OMRON

OMRON ON-LINE
 Global - <http://www.omron.com>
 USA - <http://www.omron.com/oei>
 Canada - <http://www.omron.com/oci>

OMRON CANADA, INC.
 885 Milner Avenue
 Scarborough, Ontario M1B 5V8
416-286-6465

NOTE: DIMENSIONS SHOWN ARE IN MILLIMETERS. To convert millimeters to inches divide by 25.4.

OMRON[®]

OMRON ELECTRONICS LLC

One East Commerce Drive
Schaumburg, IL 60173

1-800-55-OMRON

OMRON ON-LINE

Global - <http://www.omron.com>
USA - <http://www.omron.com/oei>
Canada - <http://www.omron.com/oci>

OMRON CANADA, INC.

885 Milner Avenue
Scarborough, Ontario M1B 5V8

416-286-6465